

# Specifications for Bypass Switch

## Housed Bypass Switch

### Description

Where no-break maintenance is required a by pass switch must be installed. It connects the supply directly to the load, "Bypass" position, and disconnects the power terminals of the inverter without interrupting the supply. When in "DPI" position the load is connected to the supply via the inverter.

### Specifications

MODEL	BPSW25A
ELECTRICAL	
Maximum current:	25A
Maximum input voltage:	600Vac
TEMPERATURE	
Maximum working temperature:	45°C (113°F)
HOUSING	
Construction:	Extruded Aluminum
Height:	202mm (7.95in)
Width:	150mm (5.9in)
Depth:	141mm (5.55in)
Mass:	1kg (2.2lbs)

### Mechanical outline

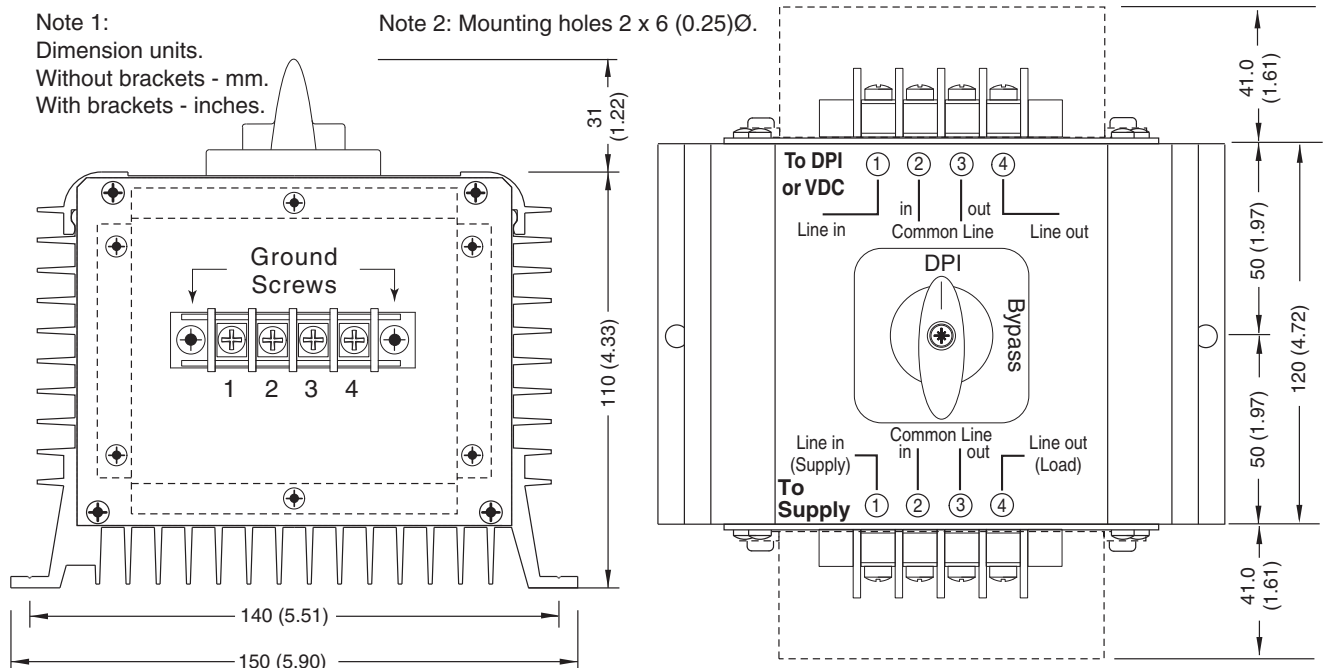

### Ordering

Stock No:  
5003-006

Description  
Housed By-Pass Switch 25Amp